

Total solder points: 38

Skill level :

Beginner 1 2 3 4 5 Advanced

TRANSISTOR IGNITION

K2543

Applications :

- Upgrade the existing ignition system of :
- Cars, motorcycles, mowers, outboards, ...
- Reduces breaker point wear
- Provides a cleaner spark
- Your own unique application

Specifications :

- For 12V negative ground systems
- Max. ignition current : 4A
- Max. switching speed : 500KHz
- Adaptable for 6V negative ground systems

modifications reserved

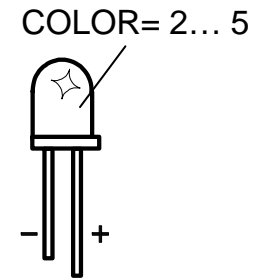
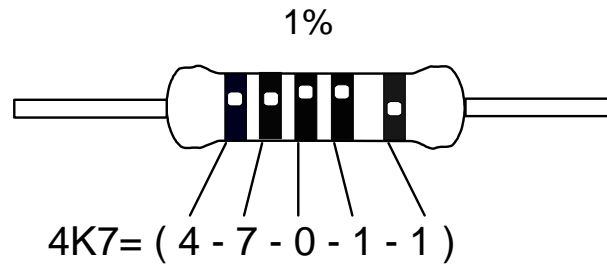
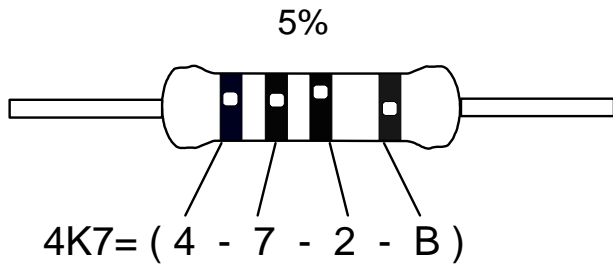



C O D E	I	P	E	SF	S	DK	N	D	GB	F	NL	C O D E
	CODICE COLORE	CODIGO DE CORES	CODIGO DE COL- ORES	VÄRI KOODI	FÄRG SCHEMA	FARVE KODE	FARGE KODE	FARB KODE	COLOUR CODE	CODIFI- CATION DES COU- LEURS	KLEUR KODE	
0	Nero	Preto	Negro	Musta	Svart	Sort	Sort	Schwarz	Black	Noir	Zwart	0
1	Marrone	Castanho	Marrón	Ruskea	Brun	Brun	Brun	Braun	Brown	Brun	Bruin	1
2	Rosso	Encarnado	Rojo	Punainen	Röd	Rød	Rød	Rot	Red	Rouge	Rood	2
3	Aranciato	Laranja	Naranjado	Oranssi	Orange	Orange	Orange	Orange	Orange	Orange	Oranje	3
4	Giallo	Amarelo	Amarillo	Keltainen	Gul	Gul	Gul	Gelb	Yellow	Jaune	Geel	4
5	Verde	Verde	Verde	Vihreä	Grön	Grøn	Grønn	Grün	Green	Vert	Groen	5
6	Blu	Azul	Azul	Sininen	Blå	Blå	Blå	Blau	Blue	Blue	Blauw	6
7	Viola	Violeta	Morado	Purppura	Lila	Violet	Violet	Violet	Purple	Violet	Paars	7
8	Grigio	Cinzeno	Gris	Harmaa	Grå	Grå	Grå	Grau	Grey	Gris	Grijs	8
9	Bianco	Branco	Blanco	Valkoinen	Vit	Hvid	Hvidt	Weiss	White	Blanc	Wit	9
A	Argento	Prateado	Plata	Hopea	Silver	Sølv	Sølv	Silber	Silver	Argent	Zilver	A
B	Oro	Dourado	Oro	Kulta	Guld	Guld	Guldl	Gold	Gold	Or	Goud	B



1. Assembly (Skipping this can lead to troubles !)

Ok, so we have your attention. These hints will help you to make this project successful. Read them carefully.

1.1 Make sure you have the right tools:

- A good quality soldering iron (25-40W) with a small tip.
- Wipe it often on a wet sponge or cloth, to keep it clean; then apply solder to the tip, to give it a wet look. This is called 'thinning' and will protect the tip, and enables you to make good connections. When solder rolls off the tip, it needs cleaning.
- Thin rosin-core solder. Do not use any flux or grease.
- A diagonal cutter to trim excess wires. To avoid injury when cutting excess leads, hold the lead so they cannot fly towards the eyes.
- Needle nose pliers, for bending leads, or to hold components in place.
- Small blade and phillips screwdrivers. A basic range is   fine.

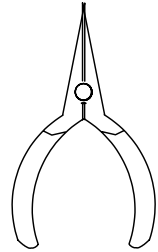
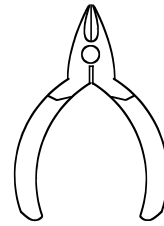
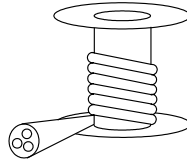
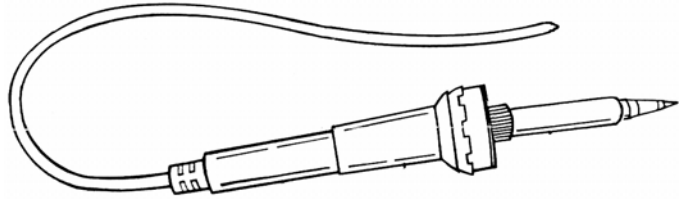

For some projects, a basic multi-meter is required, or might be handy

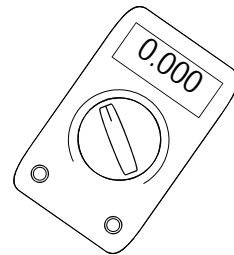

1.2 Assembly Hints :

- Make sure the skill level matches your experience, to avoid disappointments.
- Follow the instructions carefully. Read and understand the entire step before you perform each operation.
- Perform the assembly in the correct order as stated in this manual
- Position all parts on the PCB (Printed Circuit Board) as shown on the drawings.
- Values on the circuit diagram are subject to changes.
- Values in this assembly guide are correct*
- Use the check-boxes to mark your progress.
- Please read the included information on safety and customer service

* Typographical inaccuracies excluded. Always look for possible last minute manual updates, indicated as 'NOTE' on a separate leaflet.

1.3 Soldering Hints :

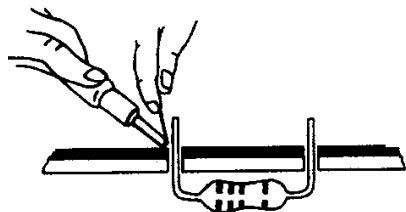

Mount the component against the PCB surface and carefully solder the leads

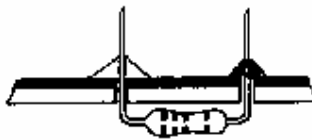

Make sure the solder joints are cone-shaped and shiny

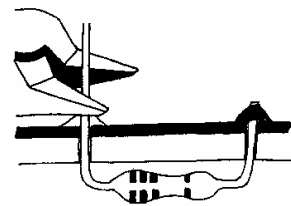

Trim excess leads as close as possible to the solder joint



AXIAL COMPONENTS ARE TAPED IN THE CORRECT MOUNTING SEQUENCE !

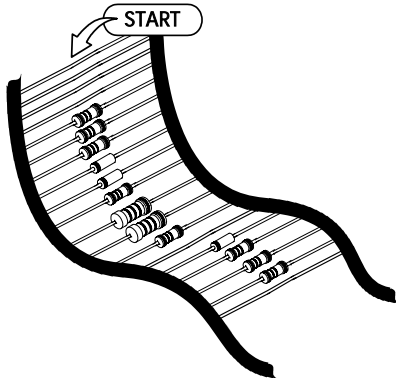

REMOVE THEM FROM THE TAPE ONE AT A TIME !

1. RESISTORS

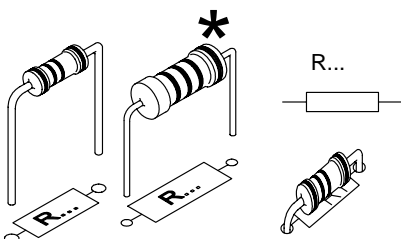

- R1 : 330 * (3 - 3 - 1 - B)
- R2 : 330 * (3 - 3 - 1 - B)
- R3 : 150 (1 - 5 - 1 - B)
- R4 : 100 (1 - 0 - 1 - B)
- R5 : 150 * (1 - 5 - 1 - B)
- R6 : 150 * (1 - 5 - 1 - B)
- R7 : 150 * (1 - 5 - 1 - B)

2. DIODES (Watch the polarity)

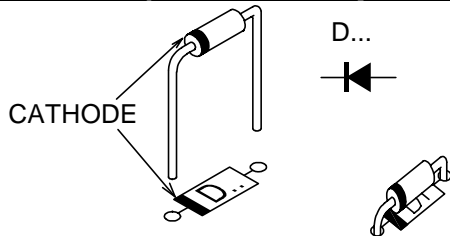

- D1 : 1N4007
- D2 : 1N4007
- D3 : 1N4007
- D4 : 1N4007

3. ZENER DIODES (Watch the polarity)

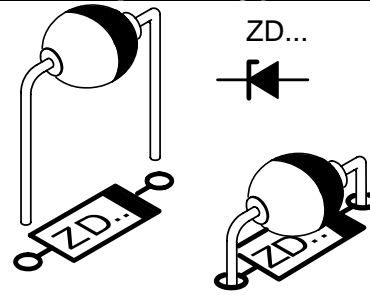

- ZD1 : 150V
- ZD2 : 150V

4. CAPACITOR

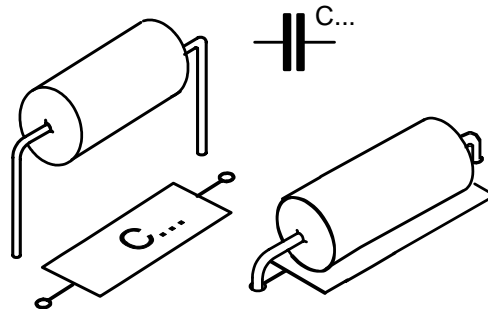

- C1 : 0.22 μ F/630V (.22; 224)

5. TRANSISTORS

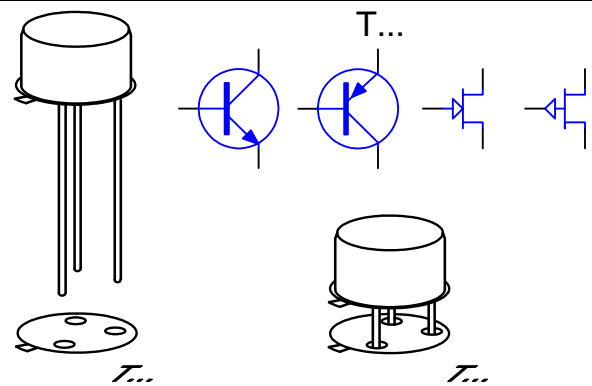

- T1 : 2N2219A, BSX45 or eq.



6. POWER TRANSISTOR MOUNTING

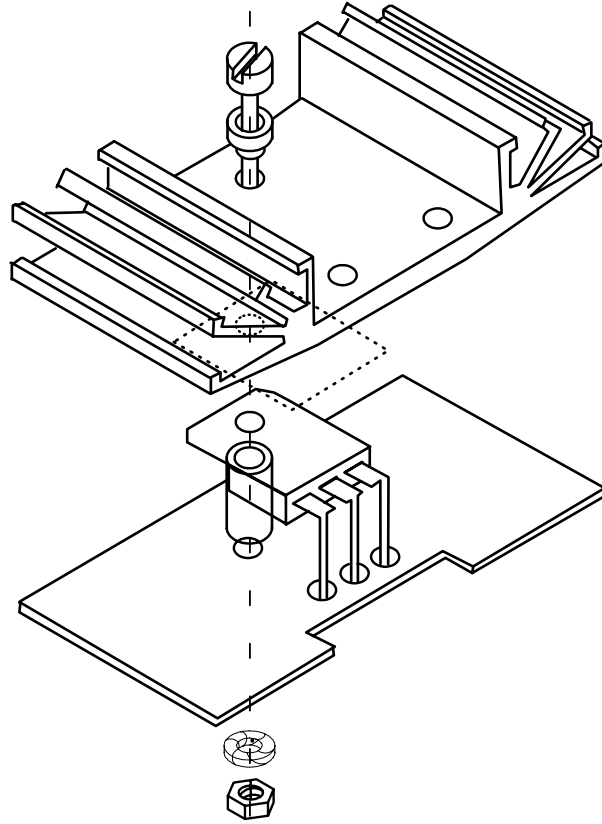

7. CONNECTION EXAMPLE

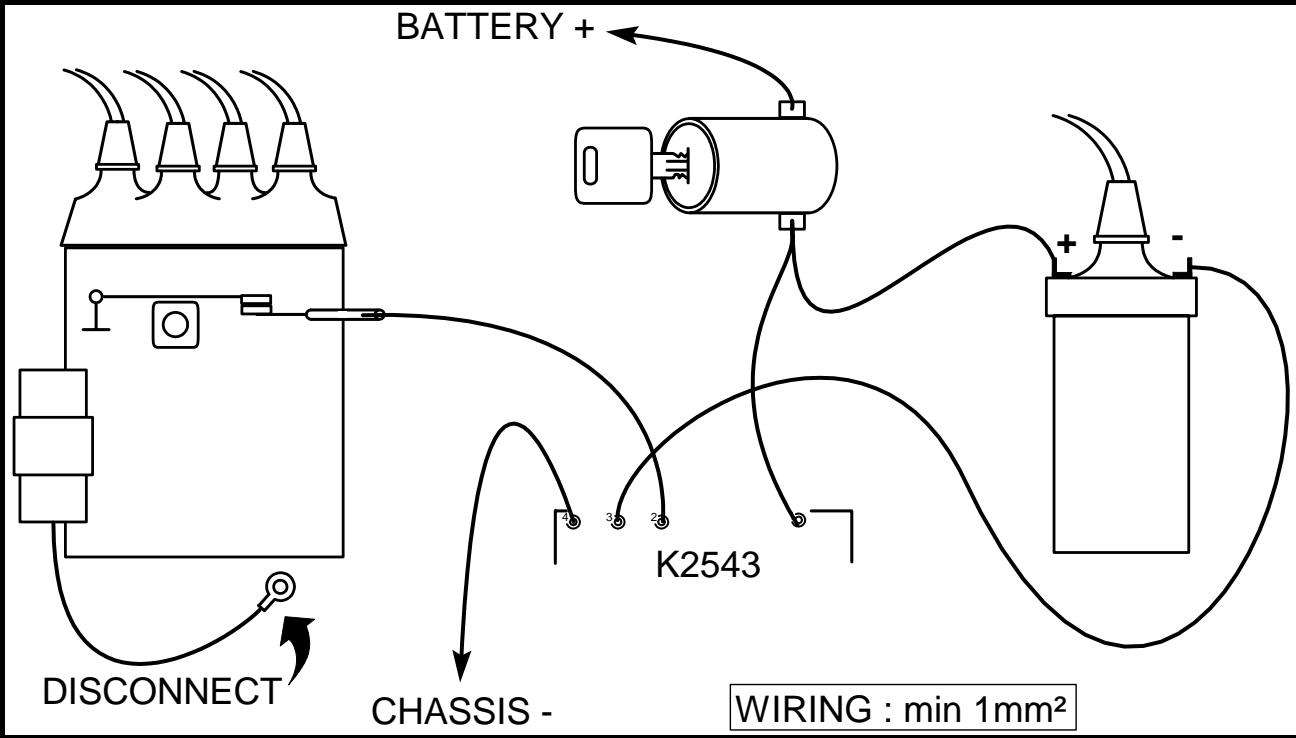



8. PCB LAYOUT

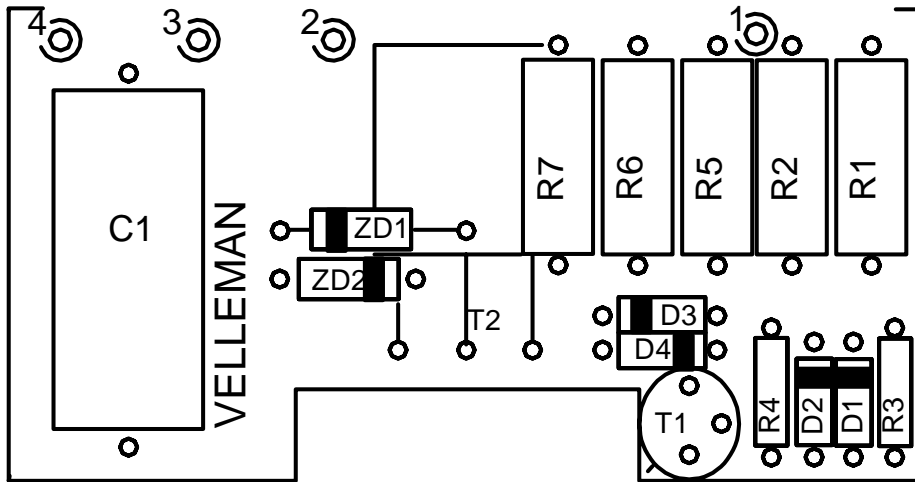

9. DIAGRAM

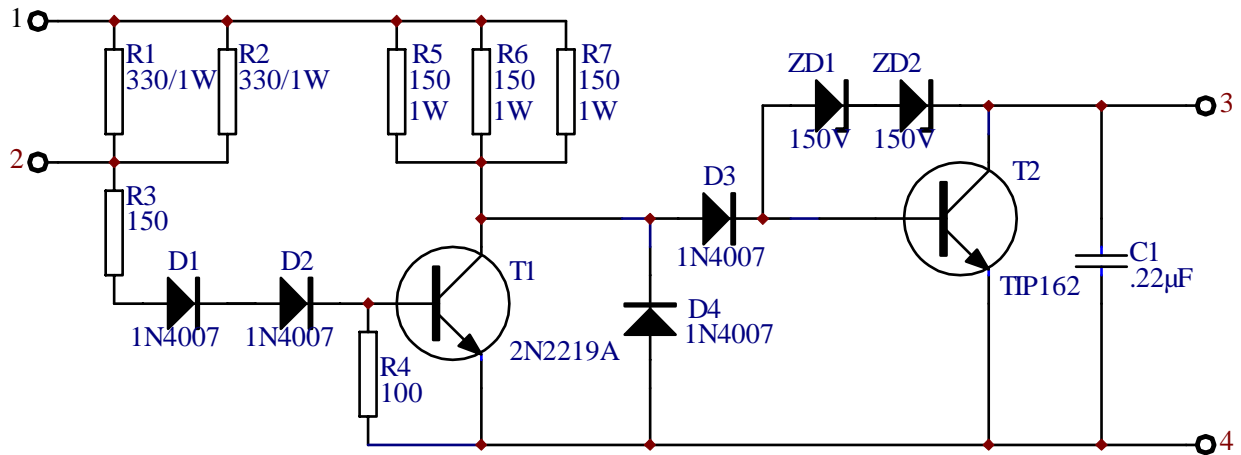

10. MODIFICATION FOR 6V NEGATIVE GROUND OPERATION

Change the following resistors :

R1,R2 : 150 / 1W
R3 : 68 / ¼W
R4 : 100 / ¼W
R5, R6, R7 : 68 / 1W